

F (1 : 2)

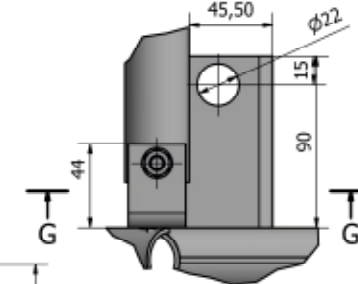

E-E (1 : 2)

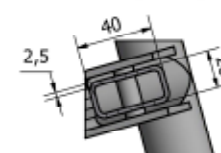

D (1 : 2)

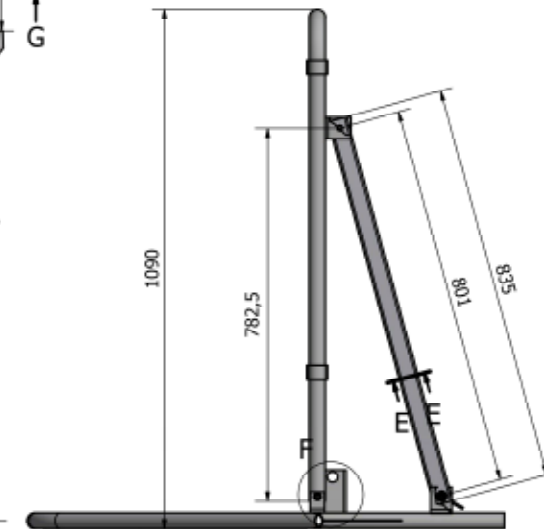
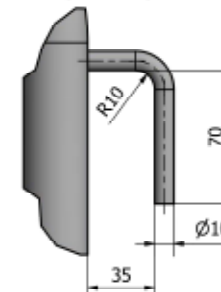

J-J (1 : 2)

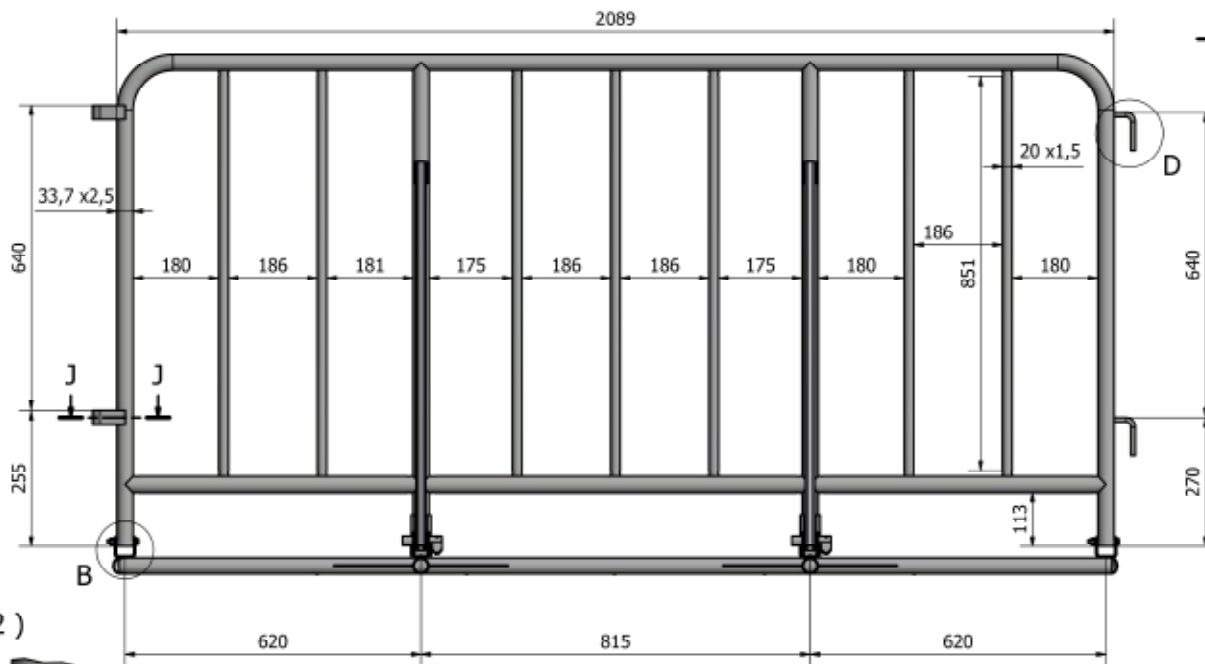
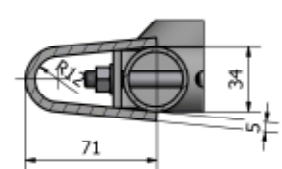

B (1 : 2)

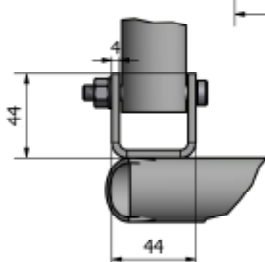

G-G (1 : 2)

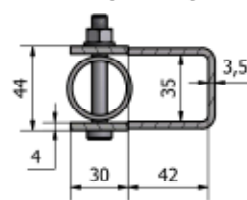

H-H (1 : 2)

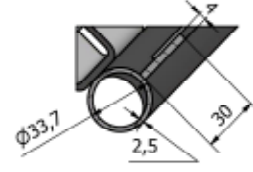

	Verkauf • Vermietung • Service <b>BauzaunProfi</b> Ihr Profi in Sachen Absperrung	Zeichnung: PG Klappbar Gezeichnet: mgr inż. Paweł Hamrol Datum: 17-06-2015
	Finish: Hot dipped galvanised	Tolerance: ±5% Weight: 48,5 kg